

# 01 Contents

<b>Contents</b>	<b>01</b>	<b>Further instructions</b>	<b>11</b>
English language contents	01	Instructions during use	11
<b>Check Various Accessories</b>	<b>02</b>		
Chair accessories	02		
Other accessories	03		
Quick Reference Guide	03		
<b>Assembly Instructions</b>	<b>04</b>		
Chair assembly	04		
Attach headrest cushion	08		
Attach lumbar cushion	09		
<b>Product Specifications</b>	<b>10</b>		
Detailed specifications	10		

## 02 Check Various Accessories Chair accessories

Please check and ensure that the following things are in the package.  
Please call the local distributor for help if something is not included.

### 1. Chair accessories



1×Backrest

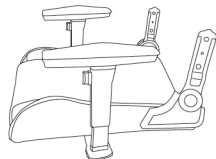

1×Seat



1×Base

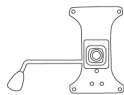

1×Control unit



1× Hydraulic unit  
Plastic cover



5×Casters



1×Plastic cover left hand side



1×Plastic cover right hand side



5×Base plastic cover



1×M8 Allen Key

## Check Various Accessories Other accessories, Quick Reference Guide

### 2. Other accessories



1×Headrest cushion



1×Lumbar cushion



1×Plastic butterfly clip

### R series Chair Quick Reference Guide

Includes the following:

- Quick Reference  
Please read before using  
This file includes Chair Maintenance  
and Product Specifications.
- After-sales Service Guide  
Warranty card and filled in sample card included.

## 1. Attach wheels

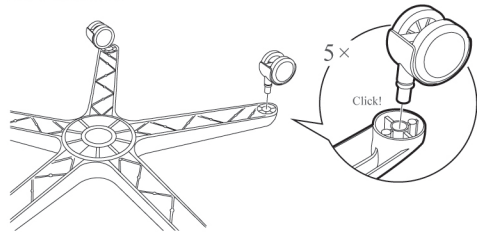

## 2. Attach plastic covers on base

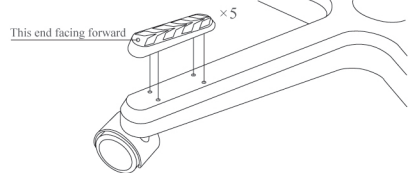
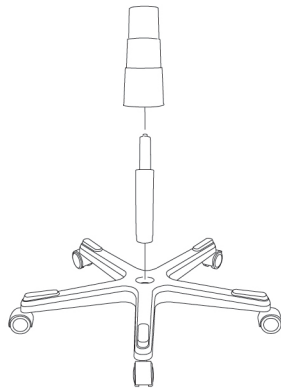
3. Install the hydraulic unit  
and the plastic cover

## 4. Attach the backrest to the seat

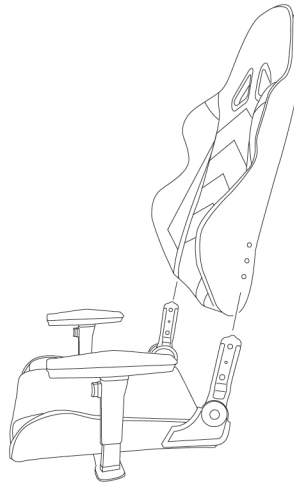
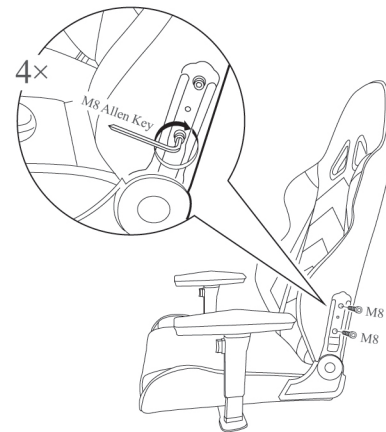
5. Using the M8 Allen key remove the screws on the side of  
the backrest and use to attach the backrest to the seat.  
(Screws come already fixed to the sides of  
the backrest before delivery)

6. Fix the plastic covers onto the sides of the backrest

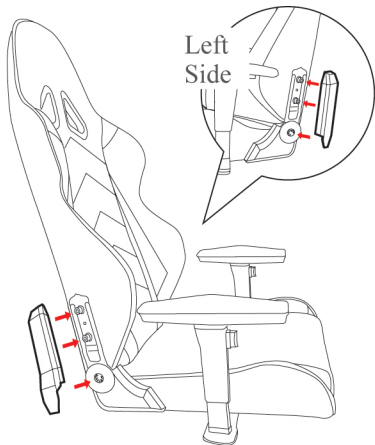

7. Fix the control unit to the base of the seat  
(Screws have been fixed to the seat base at the factory prior to delivery. Please note the direction of the control unit should be on the right.)

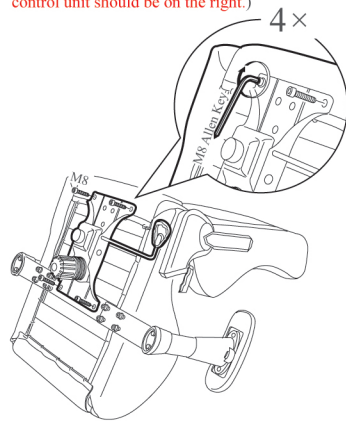

8. Insert the hydraulic unit into the opening of the control unit

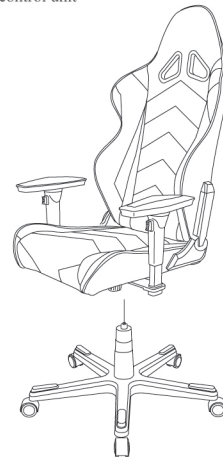

Assembly complete



## Attach Headrest cushion Method One

1. Put headrest cushion on the backrest

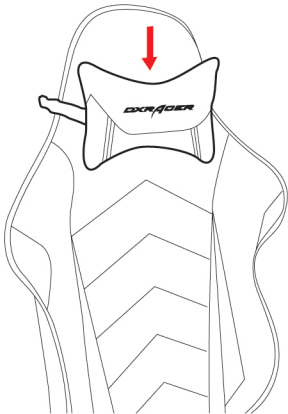

## Attach Headrest cushion Method Two

1. Insert the elastic through the plastic hole

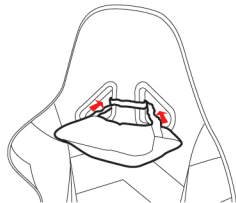

2. Tighten the elastic using the butterfly clip

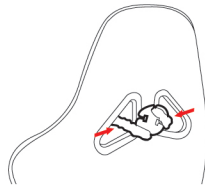

3. Complete the assembly as shown

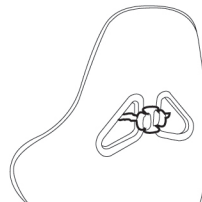

## Attach lumbar cushion

1. Lead the elastic through the aperture as shown

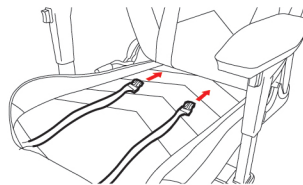

2. Attach belt clips together

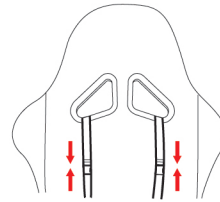

3. Adjust cushion as desired

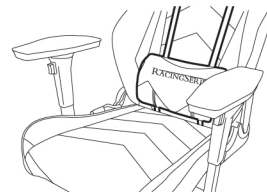

## 04 Product Specifications

### Detailed specifications



<b>A</b>	550
<b>B</b>	300
<b>C</b>	60-90
<b>D</b>	300-370
<b>E</b>	510
<b>F</b>	370-450
<b>G</b>	60
<b>H</b>	870
<b>I</b>	290-380
<b>J</b>	520
<b>K</b>	350

size (mm)

## Further instructions

### Instructions during use

#### Instructions during use

1. Please move the product gently to avoid collision;
2. Please keep out of direct sunlight;
3. Please ensure the centre of gravity is on the hydraulic unit during use;
4. Please watch your fingers when adjusting the backrest angle;
5. Please toggle the handle under your seat when adjusting the chair height, do not press it down roughly;
6. Please lift the lever gently to raise or lower the height of the chair. Do not pull it roughly;
7. Do not place any heavy objects on the chair or armrests;
8. Plastic parts will split if chair is exposed to direct sunlight;
9. Please do not use abrasive cleaners on the chair;
10. We recommend you use Pledge to clean the chair.